

## Mounting Mast(Tube)- ST-B-UM-01

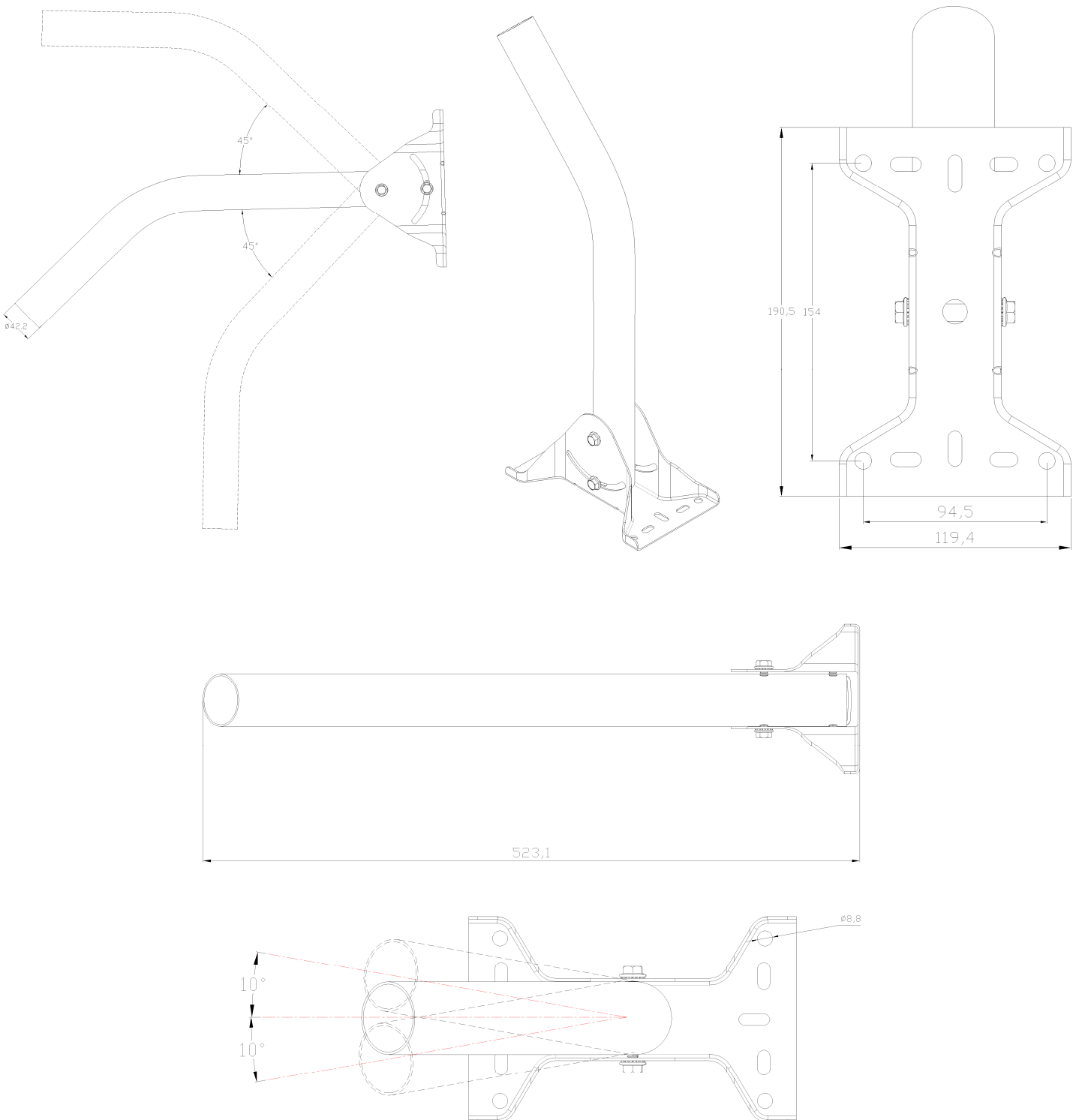

### **SANNY TELECOM EQUIPMENT CO., LTD**

Address: 202 2nd Floor, Building 3 Section B, Shihuzhou Industrial Zone, Sanshui District,  
Foshan City, Guangdong Province, China

Tel: +86 757 8766 0070

Email: [sales@sannytelecom.com](mailto:sales@sannytelecom.com)

Fax: +86 757 8766 0500

Website: [www.sannytelecom.com](http://www.sannytelecom.com)