

2.4m Ultra High Performance Antenna, Dual-Polarized, 7.125~8.5GHz
Electrical Specifications

Frequency (GHz)	7.125~8.5
Polarization	Dual (V and H)
Gain, Low (dBi)	42.3
Gain, Mid (dBi)	43.1
Gain, Top (dBi)	43.8
Beamwidth (deg)	1.2
Cross - pol. Discrimination_XPD (dB)	30
F/B Ratio (dB)	65
ISO. (dB)	35
VSWR (max)	1.3

Mechanical Specifications

Diameter (m)	2.4
Antenna Color	RAL9016
Flange Interface	UDR84 or Customized
Radome Options	High-strength Compound Fabric
Azimuth Adjustment	Coarse : 360 ° Fine : ±15 °
Elevation Adjustment	Coarse : ±10 ° Fine : ±10 °
Diameter of Mounting Pole (mm)	Φ51~Φ114
Antenna Weight (kg)	185
Wind Velocity Survival Rating (km/h)	198
Wind Velocity Operational (km/h)	110
Ice-load (mm)	25.4
Operational Temperature (°C)	- 45~+65
Packaging	Wooden

Wind Load Specifications

Axial Force (FA) (N) @ survival wind speed	17455
Side Force (FS) (N) @ survival wind speed	8598
Twisting Moment (N•m) @ survival wind speed	11545

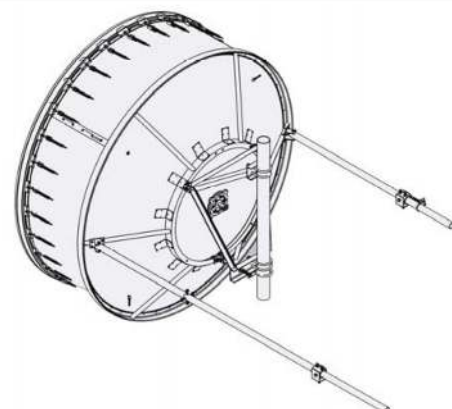
SANNY TELECOM EQUIPMENT CO., LTD

Address: Room 201 Building 1, Wanyang Industrial Park, No.82 Xiaotang Industrial Avenue,
Shishan Town, Nanhai District, Foshan City 528223, Guangdong Province, China

Tel: +86 757 8766 0070

Fax: +86 757 8766 0500

Email: sales@sannytelecom.com

Website: www.sannytelecom.com

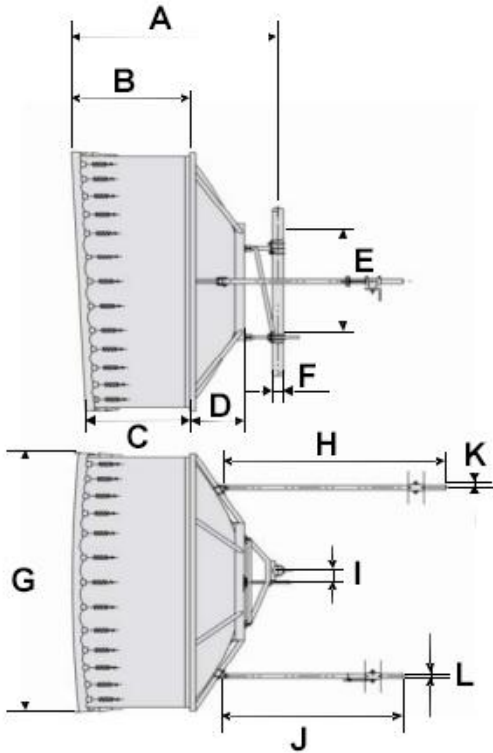

Antenna Dimensions	
All dimensions are in mm	
A	1422
B	565
C	479
D	528
E	1133
F	114
G	2511
H	3010
I	235
J	2000
K	60
L	60



SANNY TELECOM EQUIPMENT CO., LTD

Address: Room 201 Building 1, Wanyang Industrial Park, No.82 Xiaotang Industrial Avenue, Shishan Town, Nanhai District, Foshan City 528223, Guangdong Province, China

Tel: +86 757 8766 0070

Fax: +86 757 8766 0500

Email: sales@sannytelecom.com

Website: www.sannytelecom.com