

## Outdoor Low PIM Wide Band 698MHz to 4000MHz MIMO Panel Antenna

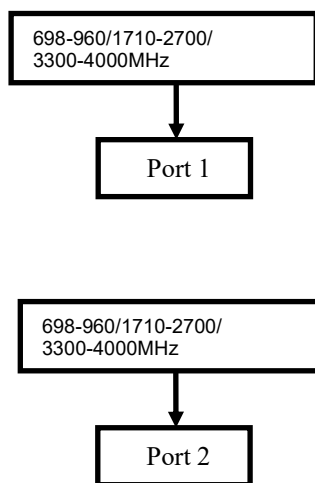

Electrical Specifications			
Model	STP74G8M2OD-P43		
Frequency Range (MHz)	698-960	1710-2700	3300-4000
Gain (dBi)	6.0±1	7.5±1	7.5±1
Polarization	±45°		
VSWR	≤1.8		
Horizontal Beamwidth	75°	70°	68°
Vertical Beamwidth	70°	70°	60°
Isolation (dB)	>20	>23	>23
PIM, Third order, 2 x 20W	≤-153 dBc		
Maximum Power	50 W		
Impedance	50 Ω		
Lightning Protection	DC Ground		
Mechanical Specifications			
Connector Type	2 x N-female /4.3-10-female		
Dimensions	308x190x82mm		
Antenna Weight	1.2 KG		
Radome Material	ABS, White, RAL9003		
Mounting Type	Mast Mount		
Relative Humidity	< 95%		
Operational Temperature	-40°C to +65°C		

### SANNY TELECOM EQUIPMENT CO., LIMITED

Address: Room 201 Building 1, Wanyang Industrial Park, No.82 Xiaotang Industrial Avenue, Shishan Town, Nanhai District, Foshan City 528223, Guangdong Province, China

Tel: +86 757 8766 0070

Fax: +86 757 8766 0500

Email: sales@sannytelecom.com

Website: [www.sannytelecom.com](http://www.sannytelecom.com)

**Horizontal  
pattern**

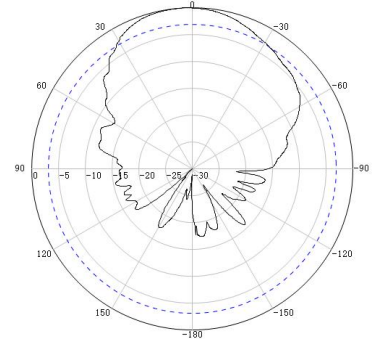
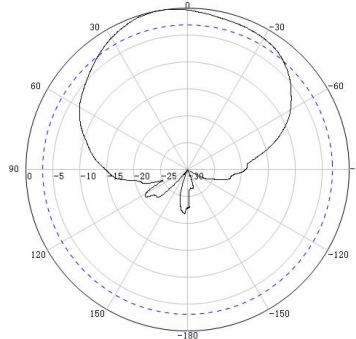
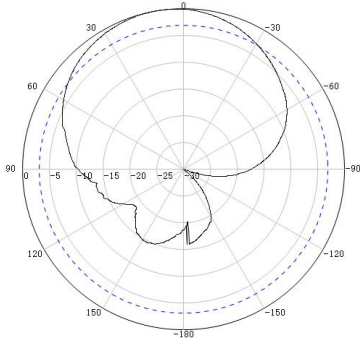

**Vertical  
pattern**

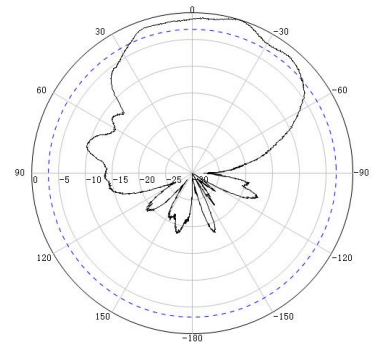
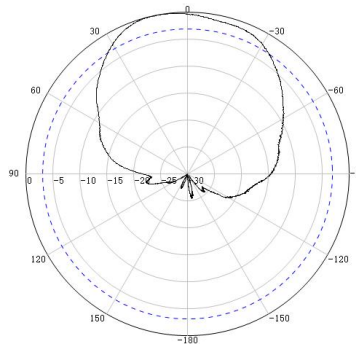
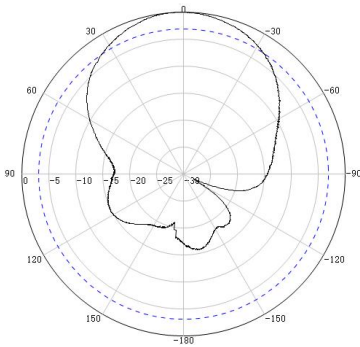

900MHz

1880MHz

2500MHz

**SANNY TELECOM EQUIPMENT CO., LIMITED**

Address: Room 201 Building 1, Wanyang Industrial Park, No.82 Xiaotang Industrial Avenue,  
Shishan Town, Nanhai District, Foshan City 528223, Guangdong Province, China

Tel: +86 757 8766 0070

Fax: +86 757 8766 0500

Email: [sales@sannytelecom.com](mailto:sales@sannytelecom.com)

Website: [www.sannytelecom.com](http://www.sannytelecom.com)